

RANCH HOUSE® DOORS

 | *Redefining the Entrance™*



Shores Collection™
Semi-Custom Garage Doors

Shores Collection™

Semi-Custom Garage Doors

www.ranchhousedoors.com

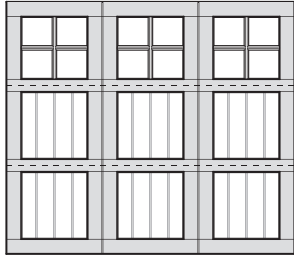

Sonesta

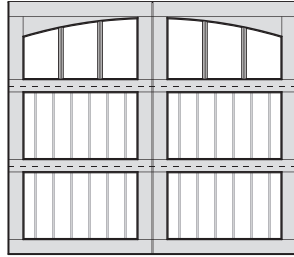

Costa Azul

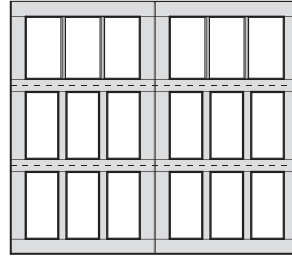

San Clemente

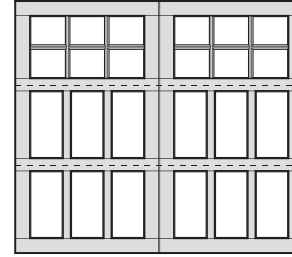

Huntington

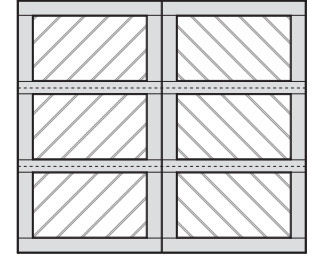

Hanauma

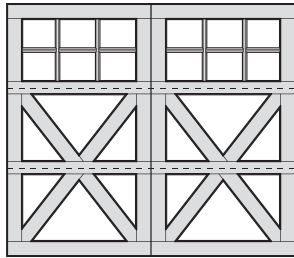

Sands

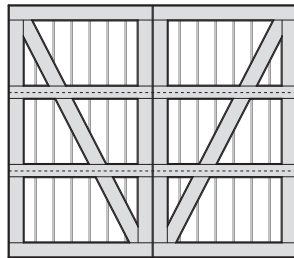

Cardiff

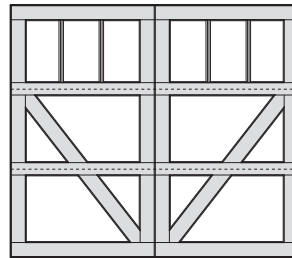

Myrtle

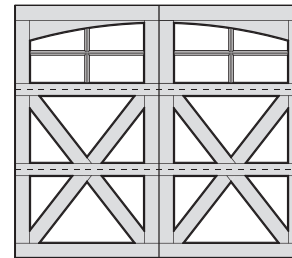

Palm

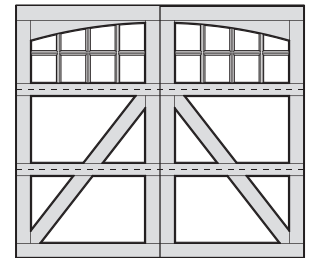

Honolulu

**doors shown are 8-0 x 7-0 – custom sizes available up 18-0 x 10-0*



RHD501



RHD519



RHD522



RHD420

 RANCH HOUSE® DOORS



RHD460



RHD505



RHD461



RHD509

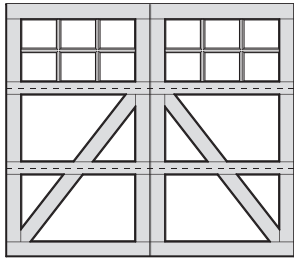

Oahu

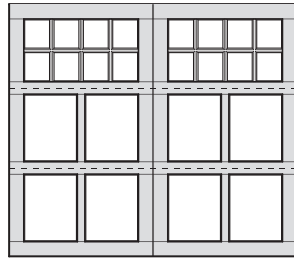

Laguna

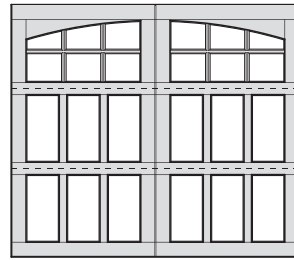

Redondo

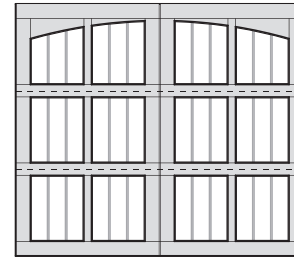

Versilla

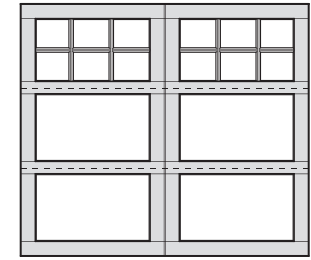

Coronado

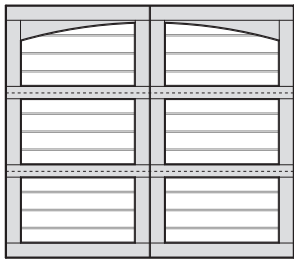

Kitsilano

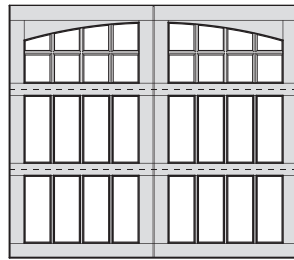

Monterey

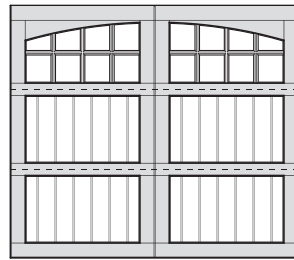

Portofino

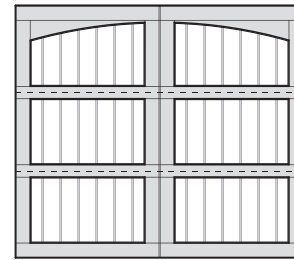

Manzanita

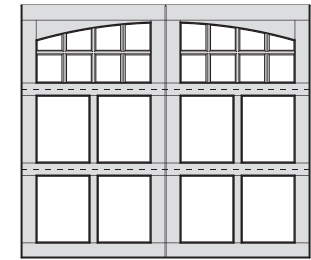

La Jolla

**doors shown are 8-0 x 7-0 – custom sizes available up 18-0 x 10-0*



RHD582



RHD583



RHD510

Window Options

NOTE: These tops are drawn for 8-0 x 7-0 doors.
The mullions are 1 1/2" and tru divide lites, unless noted otherwise.

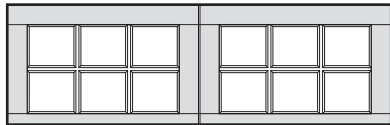

RHDC-SQ-1

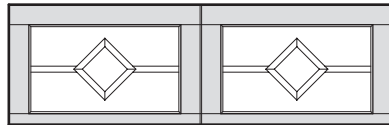

NOTE: These are overlays with 1 1/2" mullions RHDC-SQ-9

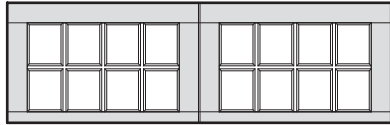

RHDC-SQ-2

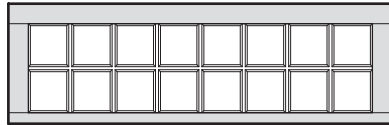

RHDC-SQ-10

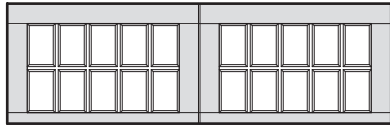

RHDC-SQ-3

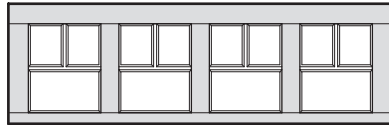

RHDC-SQ-11

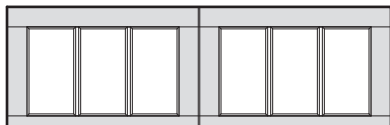

RHDC-SQ-4

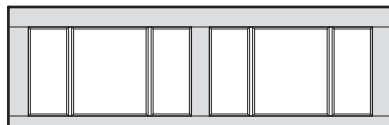

RHDC-SQ-12

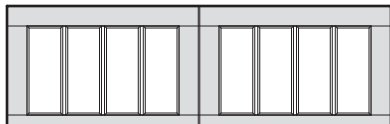

RHDC-SQ-5

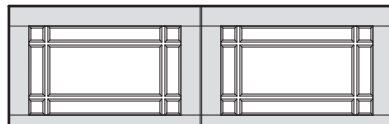

NOTE: Overlays only RHDC-SQ-13

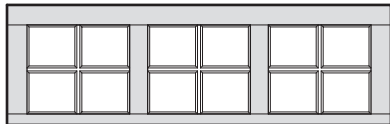

RHDC-SQ-6

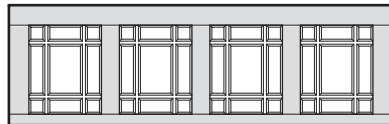

NOTE: Overlays only RHDC-SQ-14

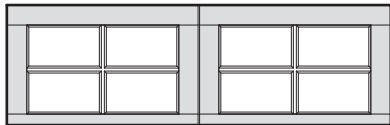

RHDC-SQ-7



RHDC-SQ-15

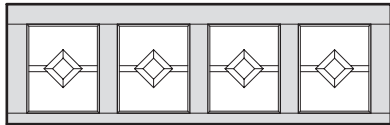

NOTE: These are overlays with 1 1/2" mullions RHDC-SQ-8



RHDC-SQ-16

*Windows are Tru Divided unless otherwise noted
*Window caulking/glazing is available upon request
*Specialty Glass Available upon request

4 Section Doors

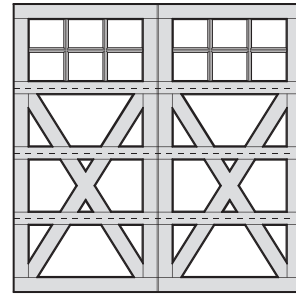

8 x 8 Sands

All doors that exceed 7'0" will be four sections. This includes but is not limited to 7'6" and 8'0" high doors. For more information on how many sections your door will be, please speak to your salesperson and request a drawing to help you achieve your unique design.

Shores Collection Specifications

Standard heights include 6'6", 7'0", 7'6", 8'0" - other heights can be custom built upon request

Stain Grade:

- 1 3/8" Deep Plow rail and stile construction
- Clear hem fir rails and stiles.
- Exterior grade birch panels with or without v-grooves
- Double center stiles with v-groove
- Tru - Divided Lites (Thru and Thru arch optional) (Window caulking optional)
- 1/2" polystyrene insulation
- Exterior stain grade luan back
- Pre drilled and pilot drilled

Paint Grade:

- 1 3/8" Deep Plow rail and stile construction
- Finger jointed hem fir rails and stiles. Clear rails optional
- Exterior grade birch panels with or without v-grooves
- Double center stiles with v-groove
- Tru - Divided Lites (Thru and Thru arch optional) (Window caulking optional)
- 1/2" polystyrene insulation
- Exterior paint grade luan back
- Primed
- Pre drilled and pilot drilled

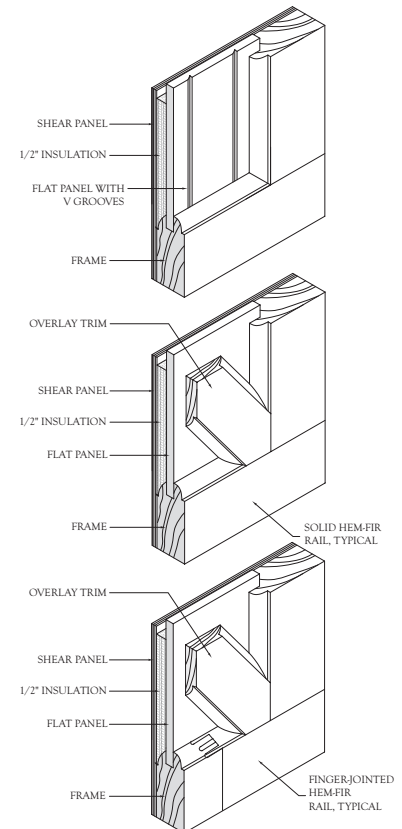



RHD411



www.ranchhousedoors.com

In 1990, Mike Neal started building custom garage door parts in his own garage in La Mirada, California. His dream was to make the best custom garage doors in the world — one door at a time. He faithfully put his hand to the plow and forged what is today Ranch House Doors, Inc. North America's leading custom garage door manufacturer.

In 2004, Mike passed away after a long fight with cancer. Although Mike is no longer with us, his vision remains the focal point for his family who continue to run Ranch House Doors, Inc. Every member of RHD is proud of his legacy and look forward to serving you with the same attention and craftsmanship that Mike, our dad and leader, taught us over the years.

— the Neal family



RHD520



RHD507b



RHD517



RHD463



RHD400